

CONFIGURATION DETAILS OF
UNDIMENSIONED FEATURES
MAY VARY

REVISIONS			
REV	DESCRIPTION	DATE	APPROVED
A0	INITIAL RELEASE	2023.01.03	

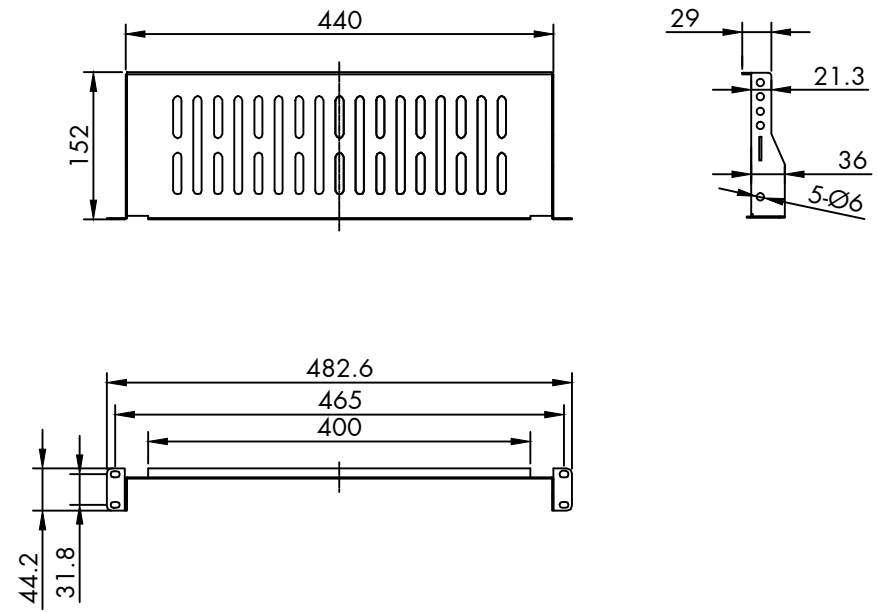

Accessory:
Screw /cage nut/ black washer ----M6*16 4sets
RoHS2.0(2011/65/EU) AND (2015/863/EU) WITH REACH COMPLIANT

NAME	VALUE 19" Cantilever Shelf 1UH, <10 kg D: 150 mm		
ITEM NO.	26.99.0400		
SECOMP	MAPE	TOLERANCE	
		X. ±1.00	
		X.X ±0.50	
	DRAW BY	SCALE	MM
	PAGE	1/1	

NO.	PART NAME	DESCRIPTION	QUANTITY	REMARKS
①	METAL	1.2MM/SPCC WITH BLACK COLOUR PAINTING	1	